

/01

OFFICE
SWEET
HOME

MARTEX

OFFICE SWEET HOME

History & Competences	pag 02
Executive & Meeting	pag 08
Managerial & Meeting	pag 26
Systems	pag 44
Workspaces	pag 56
Reception & Collaborative Areas	pag 86
Project Furniture	pag 106
Contract	pag 118

History & Competences



It is reassuring to think that a company, with over 50 years of experience, can maintain the fundamental enthusiasm with its approach to work, which exploits modern technology when creating its very own products, all with the delicateness and passion of times past. The concept which best describes our methods of understanding the product and human relationships both inside and outside our company, is the industrial craftsmanship concept.

Ci piace pensare che un'azienda, pur con 50 anni di esperienza, possa mantenere quel fondamentale entusiasmo nell'approccio al lavoro, che permette, sfruttando le moderne tecnologie, di trattare i propri prodotti con la delicatezza e la passione di una volta. Il concetto di industria artigianale è quello che più si avvicina al nostro modo di intendere il prodotto ed i rapporti umani dentro e fuori la nostra azienda.

Wir denken, dass eine Firma, trotz 50 Jahre Erfahrung, das notwendige Engagement für den Ansatz an Arbeit behalten muss. Dieser Ansatz zusammen mit den modernen Technologien ermöglicht uns unsere Produkte mit dem Sorgfalt und Leidenschaft der Vergangenheit zu behandeln. Eine handwerkliche Fertigung nähert sich meistens an unsere Produktphilosophie und an die Wertigkeit die wir an die innerhalb und ausserhalb unserer Firma menschliche Verhältnisse gewähren.

Nous aimons penser qu'une entreprise, même avec 50 ans d'expérience, peut maintenir cet enthousiasme fondamental avec son approche de travail, qui exploite la technologie moderne lors de la création de ses produits, le tout avec la délicatesse et la passion d'autrefois. Le concept de artisanat industriel est celui qui est le plus proche de notre compréhension du produit et des relations humaines à l'intérieur et à l'extérieur de notre entreprise.



Martex know how

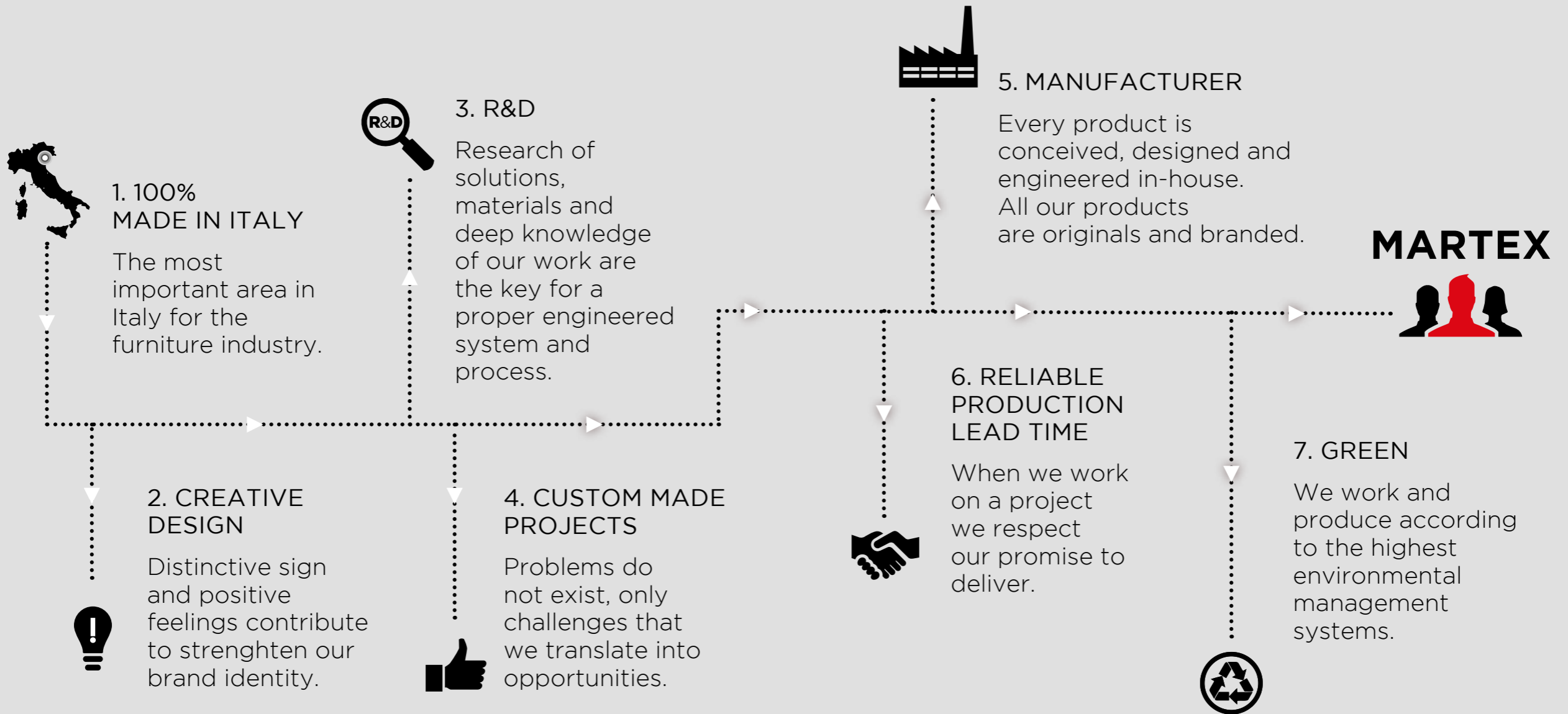

Office world seen by function

All Martex collections meet specific functional ergonomic criteria and are designed to accomplish new methods of aggregation and work sharing.

Tutte le collezioni Martex rispondono a precisi criteri di ergonomia funzionale e sono pensate per assolvere alle nuove modalità di aggregazione e condivisione del lavoro.

Alle Martex Kollektionen haben spezifische ergonomische und funktionelle Eigenschaften. Sie sind entwickelt worden mit dem Ziel die neue Bedürfnisse an Arbeitsfläche-Teilung zu erfüllen.

Toutes les collections Martex répondent aux critères précis d'ergonomie fonctionnelle et elles sont pensées pour répondre aux nouvelles modalités d'agrégation et copartage du travail.

Executive
& Meeting

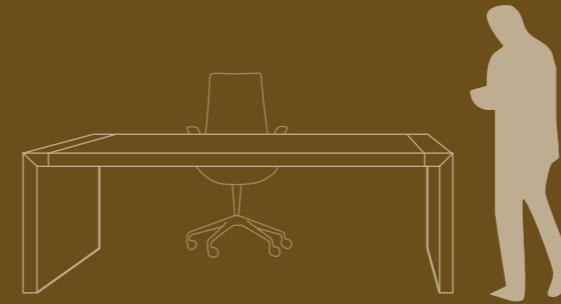

Managerial
& Meeting

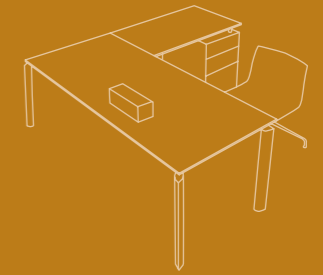

Systems



Workspaces

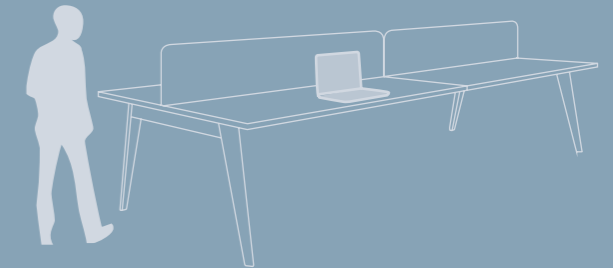

Reception &
Collaborative Areas



Project
Furniture



Executive & Meeting

Kyo
Ola

_design mario mazzer



KYO

Your luxury office

» Design icon Made in Martex

» Wide selection of materials and finishings: wood veneer, matt lacquered, glossy lacquered, back painted glass, no print glass, Fenix, cement, glossy ebony, leather, faux-leather

» Many aesthetic solutions for desks and meeting table

» Icona del design Made in Martex

» Ampia scelta di materiali e finiture: legni, laccati opachi, laccati lucidi, vetri laccati, vetri no print, Fenix, cemento, ebano lucido, pelli, ecopelli

» Molteplici soluzioni estetiche di scrivanie e meeting

» Ikone des Made in Martex Designs

» Reiche Auswahl von Materialien und Ausführungen: Hölzer, Lack matt und Hochglanz, lackierte Gläser und No Print Gläser, Fenix, Beton, Eben glänzend, Leder und Ökoleder

» Verschiedene ästhetische Konfigurationen von Schreibtisch- und Besprechungstischen

» Icône du design Made in Martex

» Ample choix de matériels et finitions: placage bois, laqués opaques, laqué brillants, verres laqués, verres non print, Fenix, ciment, ébène lucide, cuir, eco-cuir

» Solutions esthétiques multiples de bureaux et tables réunion













The beauty of this table is given by the contrast between the extra clear glass of the legs and the textured appeal of the walnut veneer top.

La bellezza di questo tavolo è data dalla contrapposizione tra le gambe in vetro trasparente extrachiaro e la matericità del piano noce.

Die Beine aus transparentem extraklarem Glas und die Feinheit der Nussbaum Tischplatten gewähren dem Besprechungstisch eine besondere Wertigkeit.

La beauté de cette table est donnée par contraposition du verre extra clair des pieds à la matérialité du plateau noyer.

OLA

Matter and form

With these awards Ola is confirmed as one of the most admired projects in the worldwide design panorama, thanks to its sign that stands for creativity and originality.

Con questi riconoscimenti Ola si conferma come uno dei progetti più ammirati nel panorama del design mondiale, grazie al suo segno che si contraddistingue per la creatività e l'originalità.

Ola, dank dieser Preise, ist ein der meist bewunderten Projekte des internationalen Designs. Es handelt sich um ein Produkt welches von Kreativität und Originalität geprägt ist.

Avec ces prix Ola se confirme comme un des projets plus admiré dans le panorama du design international, grâce à son signe qui marque la créativité et l'originalité.



reddot design award
winner 2010



ITALIAN DESIGN D&T
A PROJECT FOR ITALIAN
DESIGN FOUNDATION





Managerial & Meeting

Kyo light
Anyware
Han

_design mario mazzer



KYO LIGHT

*A functional approach
to managerial office*

- » An innovative technology for functional furnishing
- » Available in melamine, lacquered and glass finish
- » Tecnologia innovativa per un arredo funzionale
- » Disponibile in melaminico, laccato e vetro
- » Innovative Technologie für funktionelle Einrichtungen
- » Lieferbar in Melamin, Lack und Glas
- » Technologie innovante pour bureaux fonctionnels
- » Disponible en mélaminé, laqué et verre





ANYWARE

*Engineering, technology,
simplicity, reconfigurability*



Anyware has been engineered for being quick to assemble and easy to reconfigure. The entire system is assembled with a simple allen key.

Anyware è stato progettato per essere veloce da montare e facile da riconfigurare. Con una semplice chiave a brugola si effettua il montaggio di tutto il sistema.

Anyware ist geplant worden um leicht montiert zu werden und um neu konfiguriert zu werden. Das gesamte System kann mit einem einfachen Imbusschlüssel montiert werden.

Anyware a été projeté pour être rapide à monter et facile à réaménager. L'assemblage est effectué rapidement avec une clé allène.







HAN

Timeless design

- » Modular system with a wide range
- » Aluminium legs and beams or optional brill finish

- » Sistema modulare con ampiezza di gamma
- » Gambe e travi alluminio con opzione finitura brill

- » Modularsystem lieferbar in verschiedenen Ausführungen
- » Die Beine und die Traversen können in Alu oder in der Variante Brill geliefert werden.

- » Système modulaire avec ampleur de gamme
- » Pieds et poutres aluminium avec option finition brill







Systems

Anywhere
Han

_design mario mazzer



ANYWARE

Lightness and aesthetic modernity

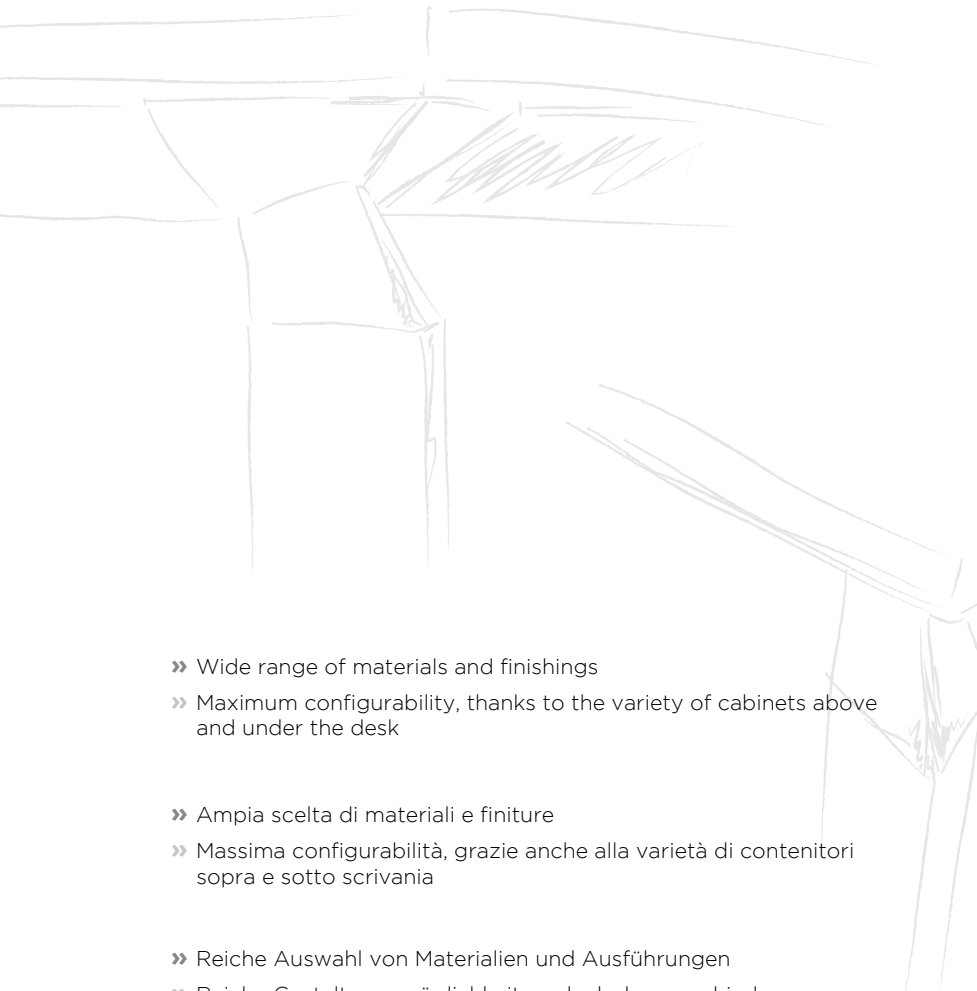
- 
- » Wide range of materials and finishings
 - » Maximum configurability, thanks to the variety of cabinets above and under the desk
 - » Ampia scelta di materiali e finiture
 - » Massima configurabilità, grazie anche alla varietà di contenitori sopra e sotto scrivania
 - » Reiche Auswahl von Materialien und Ausführungen
 - » Reiche Gestaltungsmöglichkeiten, dank der verschiedenen Container die oberhalb oder unterhalb des Schreibtisches gestellt werden können
 - » Ample choix de matériels et finitions
 - » Flexibilité maximale merci aussi à la variété de rangements sur et sous bureau





HAN

Total freedom, maximum flexibility

- » Complete solution for wire management and electrification
- » Frontal o side screen, fixed or movable, available in wood, glass or fabric, or optional acoustic material
- » Ampia scelta di tipologie di elettrificazione
- » Screen frontali o laterali, fissi o mobili, disponibili in legno, vetro o tessuto, anche nella versione fonoassorbente
- » Reiche Auswahl von Elektrifizierungsvarianten
- » Seitliche oder frontale Screen, fix oder verstellbar; sie sind in Holz, Glas oder Stoff lieferbar. Auf Anfrage lieferbar auch mit Schallabsorbtion
- » Ample choix de solutions pour le câblage
- » Cloisonnette frontales et latérales, fixes ou mobiles, en bois, verre, tissu ou matériel acoustique insonorisante







Workspaces

Pigreco_design mario mazzer

Yard_design R&D Martex & mario mazzer

Vertebra_design R&D Martex & mario mazzer



PIGRECO

Contemporary Mood

- » Structure is easy and quick to assemble and reconfigure
- » System identified by a trestle leg realized with innovative technologies
- » Struttura facile e veloce da montare e riconfigurare
- » Sistema identificato da una gamba a cavalletto realizzata con tecnologie innovative
- » Die Struktur kann leicht montiert und neu konfiguriert werden
- » Das System ist von einem Brückenbein, realisiert mit innovativen Technologien, gekennzeichnet
- » Structure facile et rapide à monter et re-configurer
- » Système identifié par un pied à "compas" réalisé avec des technologies innovantes





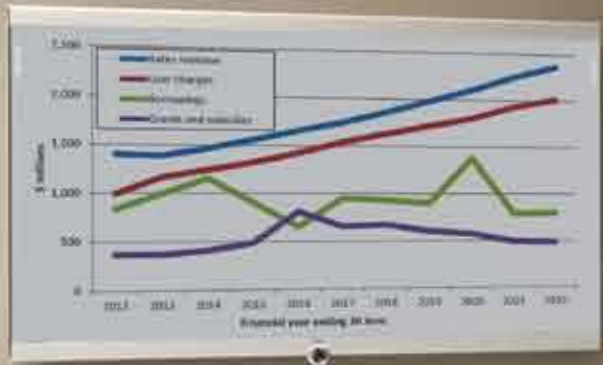

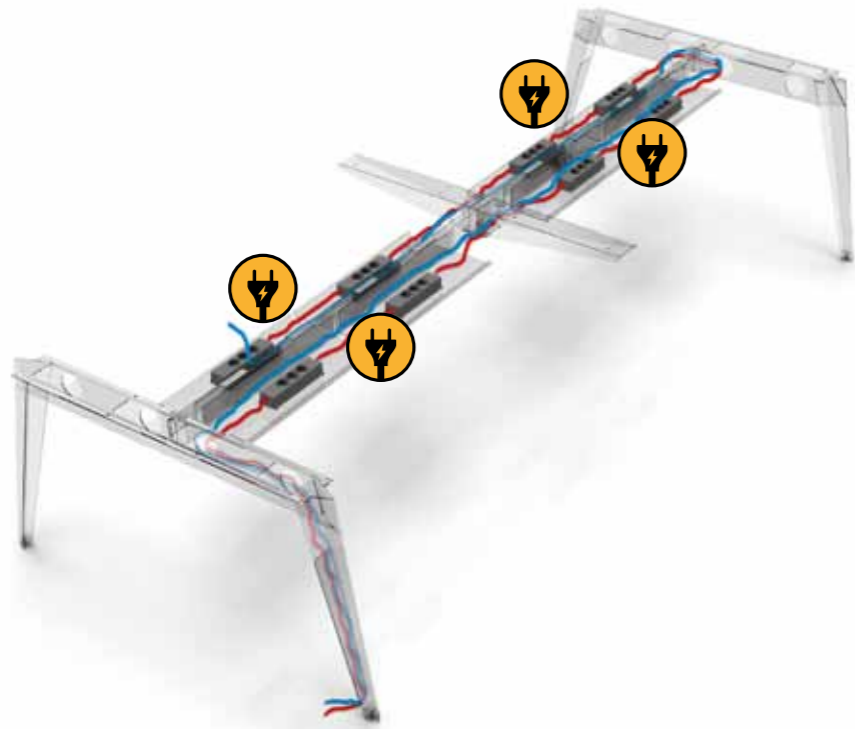

Innovative metal structure that allows a total span of 3600 mm without any central supporting element. The cable management can be effected when the workstation is completely assembled.

Struttura innovativa che permette campate fino a 3600 mm senza ausilio di supporto centrale. Il posizionamento dei cavi può essere effettuato a bench completamente montato.

Bis B. 3600 mm kann man ohne Zwischenbeine planen. Die Verlegung der Kabel kann nach Montage des Bench vorgenommen werden.

Structure qui permet une portée totale de 3600 mm sans aucune élément de support central. Le positionnement des cables peut être effectuée une fois le bench est complètement monté.







Cable rise can be made through leg and metal cover or through central cable tower when in bench configuration.

La salita cavi può avvenire lungo la gamba a compasso con carter in finitura o nella configurazione bench, tramite la gamba centrale elettrificabile.

Die Kabelführung befindet sich in dem Brückenbein und erfolgt mittels Gehäuse in der gleichen Ausführung. Die Kabelführung bei Bench-Zusammensetzungen erfolgt mittels mittleren elektrifizierbaren Bein.

La remontée des câbles peut passer par le pied «à compas» grâce à un carter de couverture en finition ou pour le bench par le pied intermédiaire.

YARD

Flexible & simple

- » Optional height adjustable leg
- » Gamba regolabile in altezza opzionale
- » Auf Anfrage, höhenverstellbare Beine
- » Pied réglable en hauteur comme option

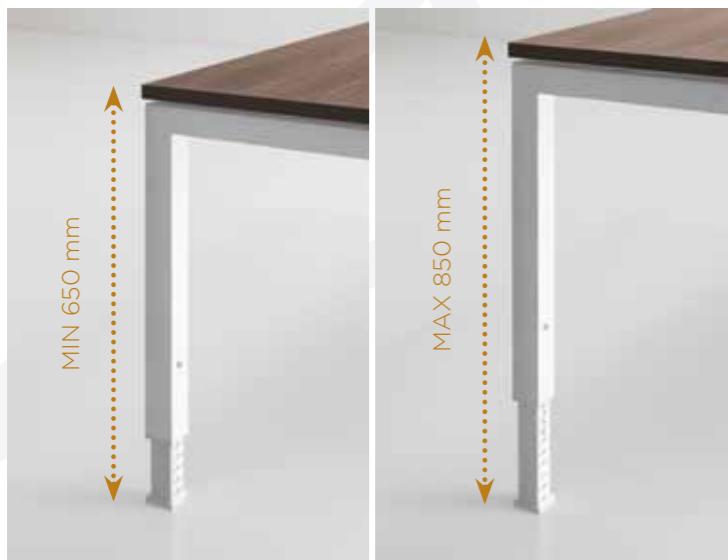







SIT TO STAND



The height adjustable desks are more and more important in the new office layouts thanks to its ergonomics and flexibility that result in psycho-physical wellness.

Le scrivanie regolabili in altezza sono sempre più importanti nella progettazione dei nuovi uffici perché, offrono flessibilità ed ergonomia, creando benessere psico-fisico.

Die hohenvestellbare Schreibtische werden immer wichtiger bei der Planung von neuen Büros; sie bieten Flexibilität und Ergonomie an und erschaffen Wohlbefinden.

Les bureaux réglables en hauteur sont de plus en plus importants dans la conception des nouveaux bureaux parce qu'ils offrent flexibilité et ergonomie, créant bien-être psychophysique.



VERTEBRA

From private to open: divide & aggregate

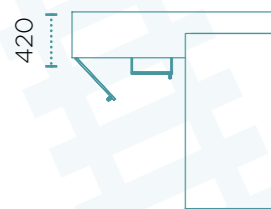

- 1.** Single sided spine
Spina monofacciale
Modul einseitig
Spine uniface

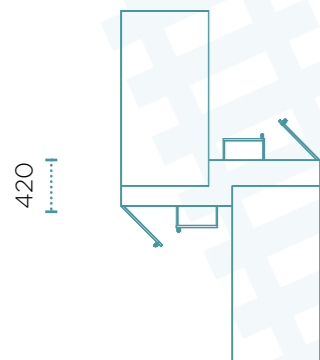

- 2.** Double sided spine
Spina bifacciale
Modul zweiseitig
Spine deux faces

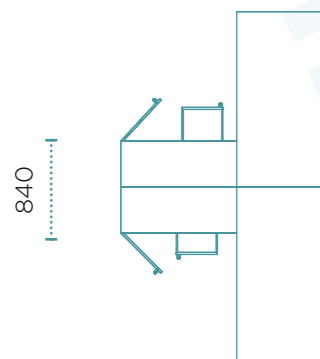

- 3.** Double low spine
Spina doppia
Doppeltes Modul
Spine double





1. Preassembled storage frame with hardware installed. **2.** Metal drawers. **3.** Ball bearing glides, full extraction with soft closing and anti-tilting mechanism, centralized locking system, weight capacity of 30 Kg. **4.** Metal cable-riser cover. **5.** Hole for cables Ø60. **6.** Height adjustable feet. **7.** Screens. **8.** Removable skirting for access to cable management.

1. Scocche dei moduli fornite premontate con ferramenta già applicata. **2.** Cassetti metallici. **3.** Guide a sfera, estrazione totale con sistema soft closing e anti-tilting, chiusura centralizzata, portata cassetto 30 kg. **4.** Carter per salita cavi. **5.** Foro passacavi Ø60. **6.** Piedini regolabili. **7.** Screens. **8.** Zoccolo ispezionabile per l'accesso all'elettrificazione.

1. Die Korpusse werden bereits montiert mit bereits angebrachten Beschlägen geliefert. **2.** Metallische Schubladen. **3.** Kugellagerschienen, Vollauszug mit Softclosing und kippsicher-System. Schliessung mit Zentralverriegelung. Tragfähigkeit einer Schublade bis 30 KG. **4.** Gehäuse für Kabelausgang. **5.** Kabeldurchgang 60 mm Durchmesser. **6.** Hohenverstellbare Füße. **7.** Screen. **8.** Abnehmbarer Sockel, um an die Elektrifizierung Zugang zu haben.

1. Structures de meuble livrés pré-assemblés avec ferrure appliqué. **2.** Tiroirs en métal **3.** Glissières sur roulement à billes, extraction totale avec système anti-basculant et fermeture en douceur, verrouillage central, charge 30 kg. **4.** Carter pour la remontée des câbles. **5.** Obturateur Ø60. **6.** Pieds réglables. **7.** Cloisonettes. **8.** Socle ouvrant pour l'accès à l'elettrification.



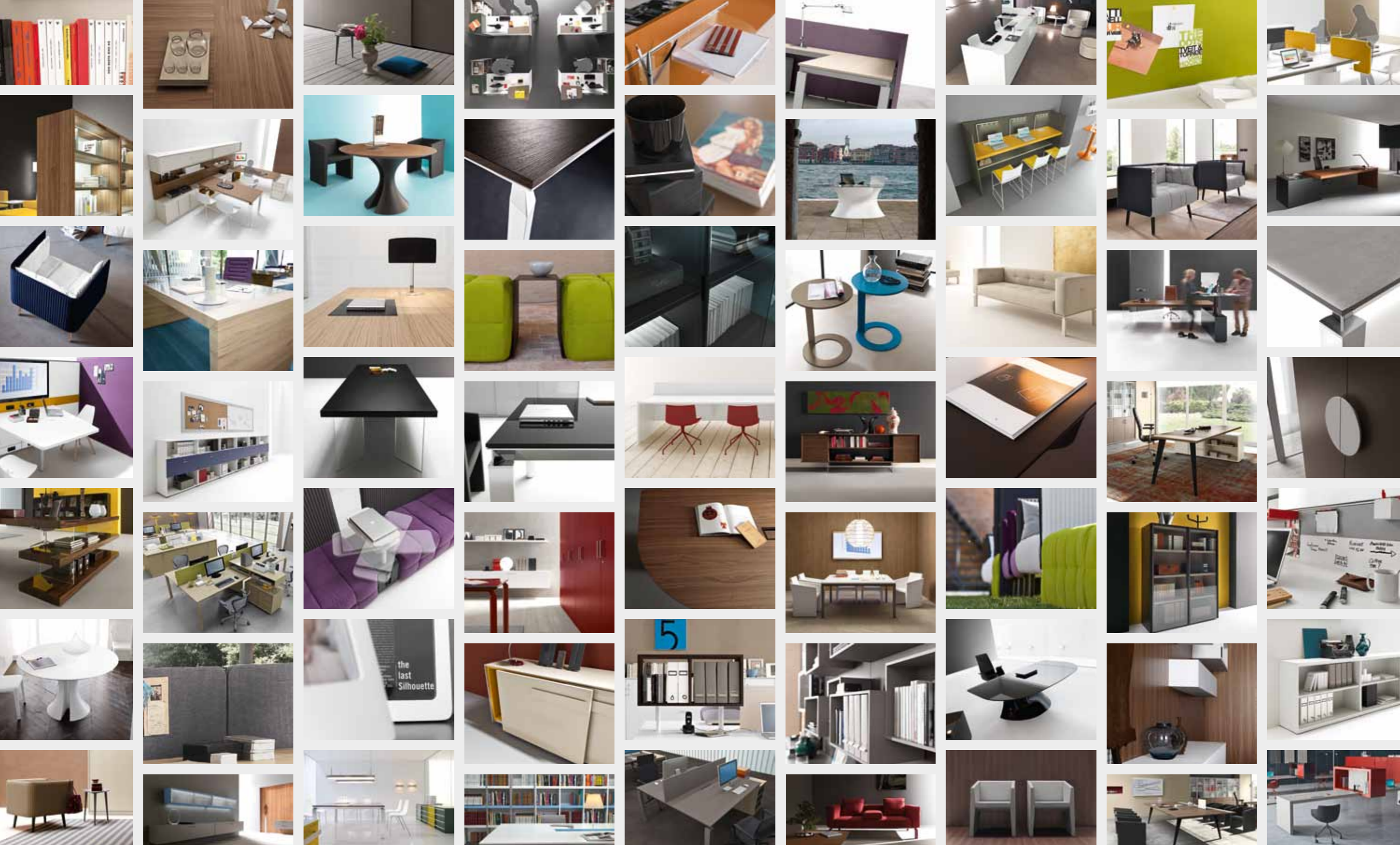

Reception & Collaborative Areas

Shelter _design R&D Martex

Inattesa _design monica graffeo

Pod _design R&D Martex

Dual _design mario mazzer



SHELTER

Welcome your guests

Shelter reception is composed by a system of modular panels that, combined to each Martex desk, allow complete freedom of composition and configurations.

La reception Shelter è composta da un sistema di pannelli modulari che, combinati ad ogni scrivania Martex, permettono la totale libertà di composizione e configurazione.

Der Shelter Empfang besteht aus modularen Paneelen, die mit allen Martex Schreibtischen kombiniert werden können. Das ermöglicht eine absolute Gestaltungsmöglichkeit.

Le reception Shelter est composé d'un système de panneaux modulaires que, combiné à chaque bureau Martex, permettent la totale liberté de composition et configuration.







CUBIK

INTERNET
POINT



INATTESA

CONNECT

HOT
DESK



ROMI



INATTESA

Lounge, meeting, working

- » Modular and freestanding upholstered furniture
 - » Tables and connect accessories
 - » Wide range of fabrics available
-
- » Imbottiti modulari e free standing
 - » Accessori quali tavolini e connect
 - » Ampia gamma di tessuti
-
- » Gepolstertes Modularsystem und freistellbare Module
 - » Beimöbel (Tischchen und Verbindungselemente)
 - » Reiche Auswahl von Stoffen
-
- » Modules rembourrés de différentes typologies et hauteurs
 - » Accessoires comme petit tables et modules connection
 - » Gamme ample de tissus







POD

*Individual work, team working
& communication*

1.

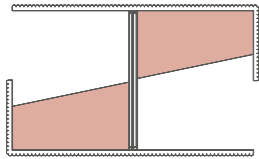

2.

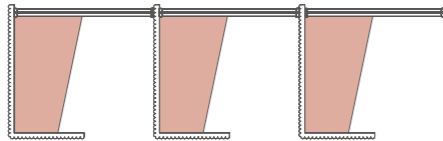

3.

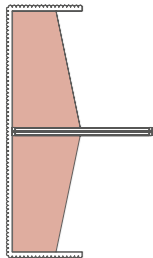

4.

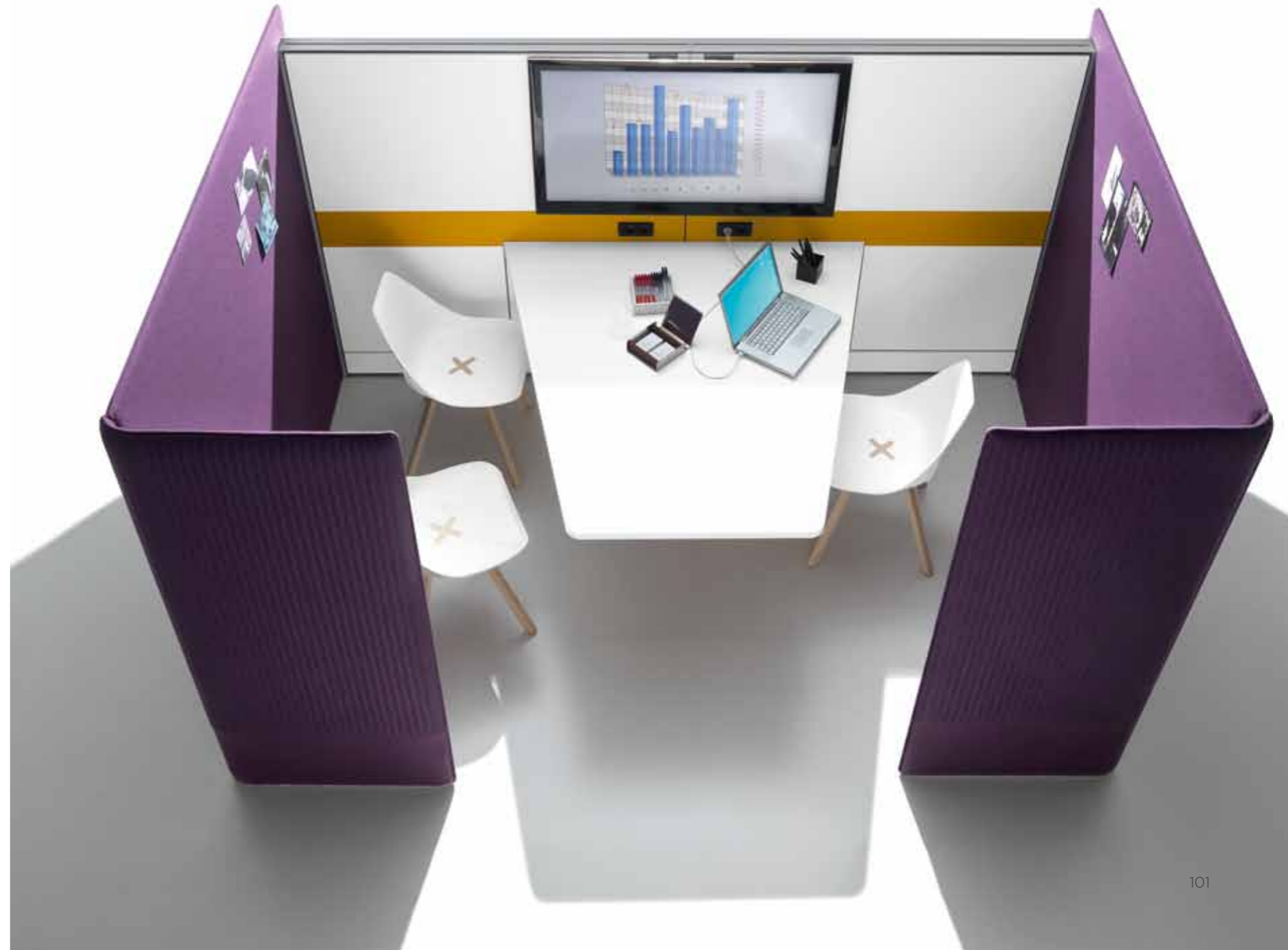
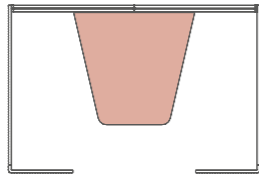

 **61%**
absorbing
surface

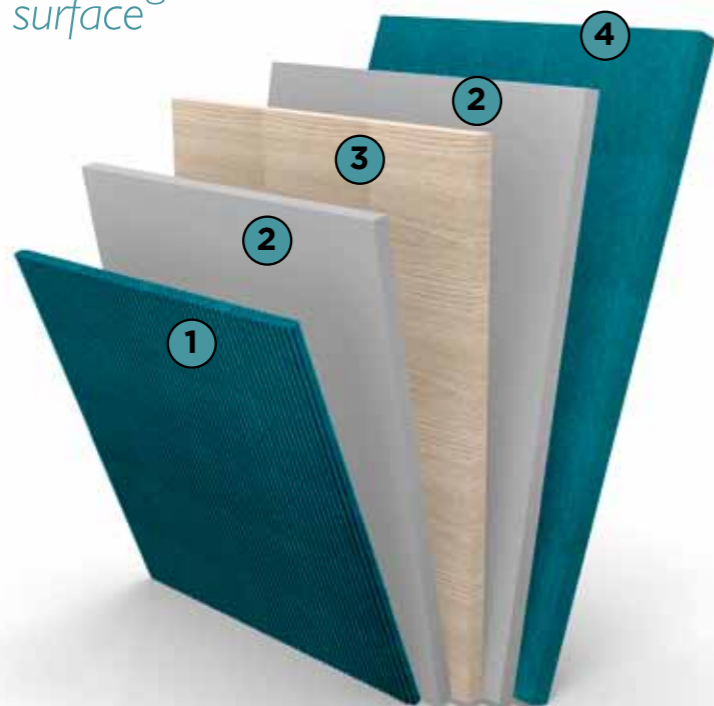

1. External thermoformed panel in stretchy 3D or pure new wool 3D. **2.** Acoustic panels in elastic foamed resin with completely opened cells fire resistant. **3.** Multilayer th. 18 mm. **4.** Internal fabric in pure new wool, or stopfire.

1. Tessuto termoformato esterno in stretchy 3D o 100% lana 3D. **2.** Pannelli acustici in resina espansa a celle aperte con resistenza al fuoco. **3.** Multistrato sp. 18 mm. **4.** Tessuto interno in 100% lana, o stopfire.

1. Thermoformiertes Stoff aussen in Stretchy 3D oder in 100% Wolle 3D. **2.** Akustische Paneele in offenzelligen Schaumstoff Harz, mit Feuerbeständigkeit. **3.** Mehrschicht-Material St. 18 mm **4.** Interner Stoff in 100% Wolle oder Stopfire.

1. Tissu thermoformé externe stretchy 3D ou laine bouillie 3D. **2.** Panneaux acoustiques mousse de résine à cellules ouvertes ayant une résistance au feu. **3.** Multicouche épaisseur 18 mm. **4.** Doublure en laine bouillie, ou stopfire.



DUAL

Find your best posture

1..

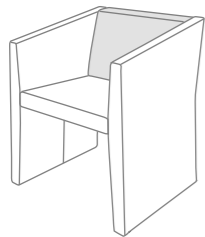

2..

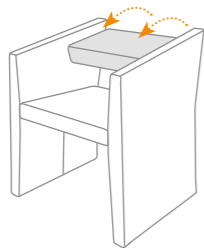

3!

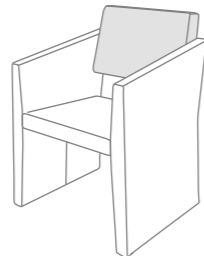

Its duality, tub chair or high back, in boardrooms allows finding everyone's best posture.

Nelle sale conferenza, la sua dualità, pozzetto o schienale alto, consente a ciascuno di trovare la propria postura ideale.

Dank der zwei Stellungen des Rückwandpaneels, kann Dual Sessel eine optimale Körperhaltung gewähren.

Dans les salles conférence sa dualité, bridge ou dossier haut, consentent à chaque de trouver la propre posture idéale.



Project Furniture

Te⁰⁸ _design R&D Martex

Net _design R&D Martex



TE⁰⁸

- » Layout and spaces separation
- » Modularity
- » Integrated wire management

- » Layout e separazione spazi
- » Modularità
- » Elettificazione integrata

- » Layout und Trennung der Räumen
- » Modulares System
- » Integrierte Elektrifikation

- » Layout, space planning et séparation
- » Modularité
- » Câblage intégré





Cable management

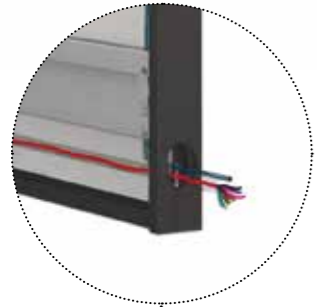

- 1
- » Cable passage: from side trim through opening
- » Passaggio cavi: tramite un foro nel profilo laterale
- » Kabelpassage: mittels einer Bohrung in dem seitlichen Rahmen
- » Passage des câbles: de côté garniture à travers l'ouverture



- 2
- » Cable passage: from skirting through opening
- » Passaggio cavi: tramite i fori nello zoccolo
- » Kabelpassage: mittels Bohrungen in den Sockel
- » Passage des câbles: de plinthe à travers l'ouverture



- 3
- » Cable passage: from raised floor through floor tray
- » Passaggio cavi: dal pavimento tramite un foro nella vaschetta
- » Kabelpassage: vom Boden in den unteren Rahmen mittels einer Bohrung
- » Passage des câbles: de plancher surélevé par bac de plancher



NET

- » Panel th. 30 mm
- » Height adjustable range
- » Connection system among top, leg and modesty panel

- » Pannello sp. 30 mm
- » Gamma modulabile in altezza
- » Sistema di aggancio tra piano, gamba e modesty

- » Paneel St. 30 mm
- » Kollektion modulierbar in der Höhe
- » Verbindungssystem zwischen Platte, Bein und Modesty

- » Panneau ép. 30 mm
- » Gamme modulaire en hauteur
- » Système de liaison entre plateau, pied panneau et voile de fond



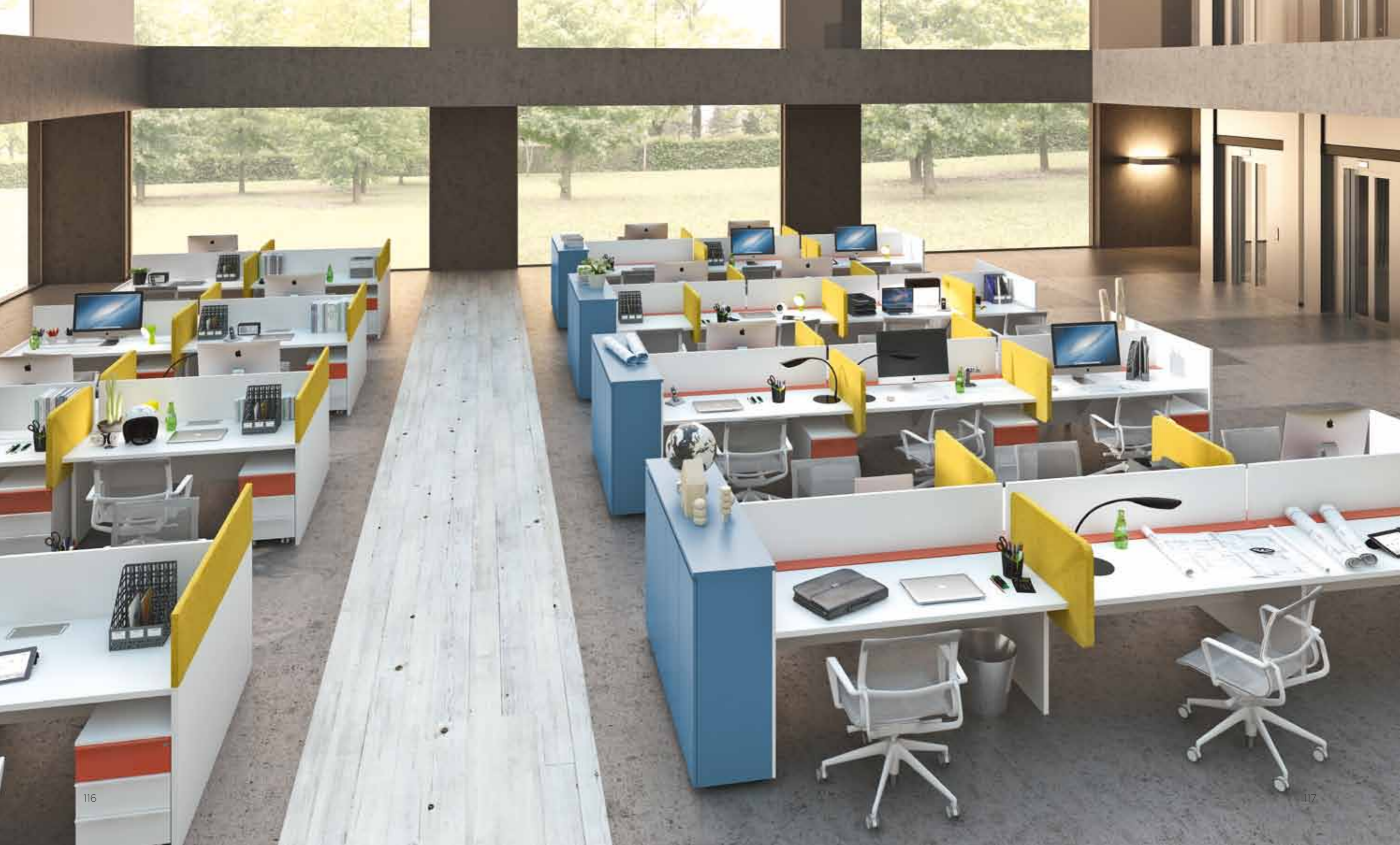

Contract

“Discoveries consist in seeing what everyone sees and think what nobody thought”

* (Albert Szent Gyorgyi, Nobel Prize for Medicine - 1937)



Our method

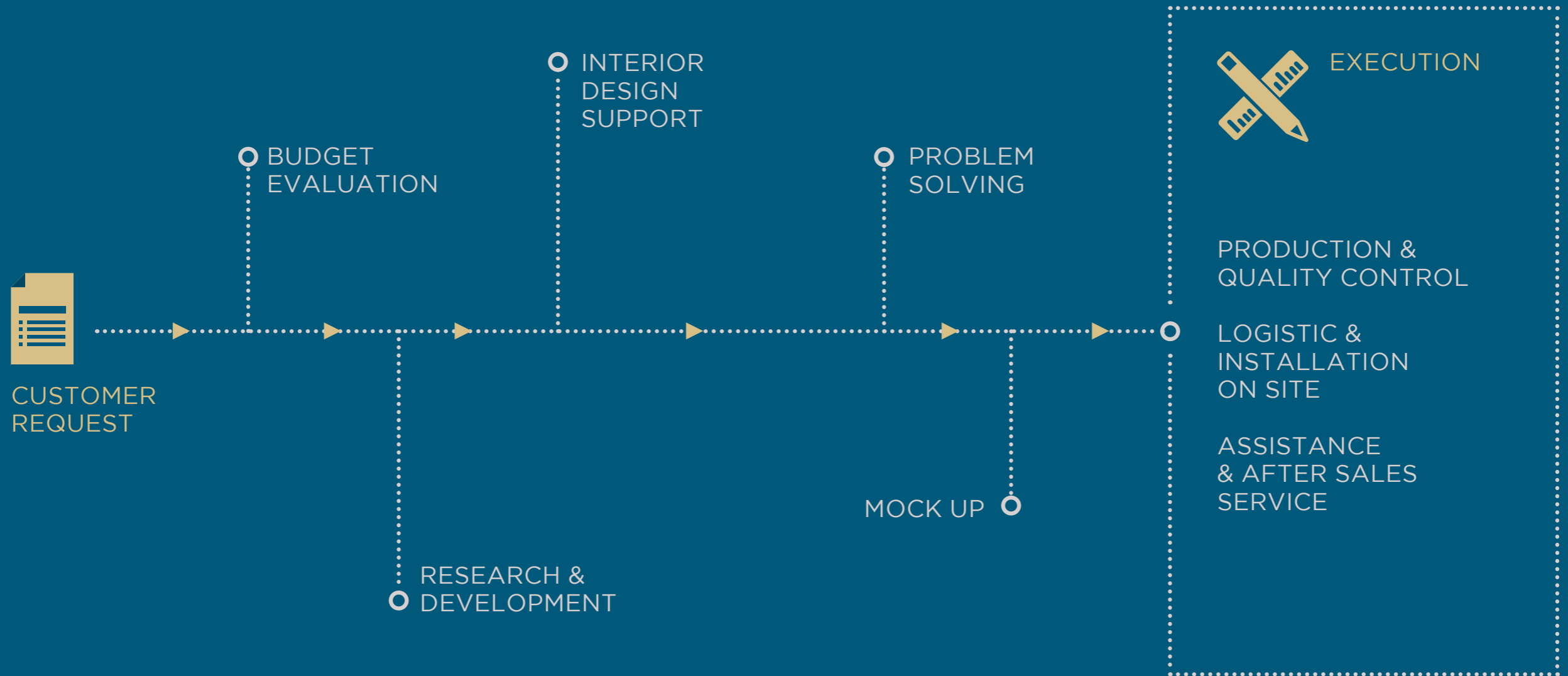

Reference list

ESSECI	Italy	SANOMA MAGAZINES	Belgium
EUROCOMPANY	Italy	JTI	Belgium
PRODECO PHARMA	Italy	LEXMARK	Belgium
LA MERIDIANA	Italy	LP CONSULT	Bulgaria
HOS	Italy	GROUP M	France
SACA INDUSTRIE	Italy	AIR LIQUID	France
AMBASCIATA FRANCESE	Italy	SOLINEST	France
MONT BLANC	Italy	SHEARMAN	France
ITAP	Italy	ST. JUDE MEDICAL	France
PROMOS	Italy	GUY CARPENTE	France
MICROTEK	Italy	HOREMIS, M. TEDESCHI	France
HOMES	Italy	ALBIN MICHEL	France
BCC MARCON	Italy	ANTHOGYR	France
CA' ANNELISE	Italy	FOUQUET SACOP	France
BANCA DI CREDITO		BARCLAYS BANK	France
COOPERATIVO	Italy	ALPHEN RHEIN	Holland
FASSA BORTOLO	Italy	UNIVERSITY COLLEG DUBLIN	Ireland
UNINDUSTRIA	Italy	JONES LANGE LA SALLE	Ireland
GAS NATURAL - HQ	Italy	TNT EXPRESS	Ireland
IVECO - HQ	Italy	BEI (BANQUE EUROP. INVEST)	Luxemburg
MELIA HOTEL	Italy	ENERGIAPRO	Poland
UNICREDIT	Italy	IP STUDIO STRUGAR D.O.O	Serbia
ERG - HQ	Italy	EURODIAGNOSI	Slovakia
AKKA BENELUX	Belgium	20 MINUTOS	Spain
EUROPEAN		EURO HOUSE	Spain
BANK FEDERATION	Belgium	POLARIS WORLD	Spain
SHERMAN & STERLING	Belgium	BMW	Spain
FIAT	Belgium	FERRARI	Spain
TESSEENDERLO	Belgium	CHRISTIAN BERNARD	Switzerland
SOFINA	Belgium	WEB FOUNTAIN	Switzerland
CUSHMAN & WAKEFIELD	Belgium	MN TRUST	Switzerland

ALTIS GROUP	Ukraine	ABBOTT LABORATORIES	Dubai
NEW CASTLE COLLEGE	UK	NISSAN	Dubai
ST.PETER HUDDERSFIELD	UK	ROYAL EMBASSY OF KSA	Egypt
MCLAREN RACING	UK	BOEING	Israel
ST. GEORGES	UK	KAMINARIO GROUP	Israel
INTO NEWCASTLE	UK	ROYAL EMBASSY OF KSA	Jordan
EVOLVE TELECOM	UK	NATIONAL SECURITY	Qatar
INTO MILE END	UK	BARWA REAL ESTATE - HQ	Qatar
EXETER	UK	KATARA CULTURAL VILLAGE	Qatar
MIDREX	UK	AL JAZEERA - HQ	Qatar
THYSSENKRUPP	UK	BARWA BANK - HQ	Qatar
DORINVEST	Russia	BABSON COLLEGE - KAEC	KSA
EASTWARD CAPITAL	Russia	AL RAJHI INVESTMENT	KSA
JAPAN TOBACCO INT.AL	Russia	NCB CAPITAL - HQ	KSA
GAZKOMPLEKTINVEST	Russia	KING SAUDI UNIVERSITY	KSA
MC DONALD'S	Russia	TOYOTA	KSA
SBERBANK	Russia	MA'ADEN GOLD	KSA
TERRAS OFFICE GAZPROM	Russia	KAPSARC	KSA
TECHNOPARK	Russia	KPMG	KSA
UNITED EUROPE HOLDING	Russia	HRDF	KSA
VIZA-WEST	Russia	AL INMA BANK	KSA
YANDEX	Russia	HALWANI BROS.	KSA
HYUNDAI - REGIONAL HQ	Russia	ISLAMIC DEVELOPMENT BANK	KSA
ATRIUM INNOVATION	Canada	NESTLÉ	Thailand
BINDI	USA	ALLIANZ	Singapore
IBM	USA	NOVARTIS - REGIONAL HQ	Singapore
TELECOM ITALIA	USA	NOKIA - REGIONAL HQ	Singapore
NESA	Abu Dhabi	RNA	India
MUBADALA - Capital Tower	Abu Dhabi	SUN TV	India
J. SAFRA SARASIN BANK	Abu Dhabi	ACUA MARINE	India
KPMG	Bahrain	AKZONOBLE	India
NCB CAPITAL - HQ	Bahrain	ATLAS	India
KUWAIT FINANCE HOUSE	Bahrain		
CREDIMAX - HQ	Bahrain		
EXPO 2020 - Emirates Towers	Dubai		
CHANEL HQ - D3 District	Dubai		
EMS PROJECT	Dubai		

FINISHINGS _ FINITURE _ AUSFÜHRUNGEN _ FINITIONS

MATT LACQUERED COLOURS / LACCATI OPACHI / LACK MAT / LAQUÉ MAT



GLOSSY LACQUERED / LACCATI LUCIDI / LACK HOCHGLANZ / LAQUÉ BRILLANT

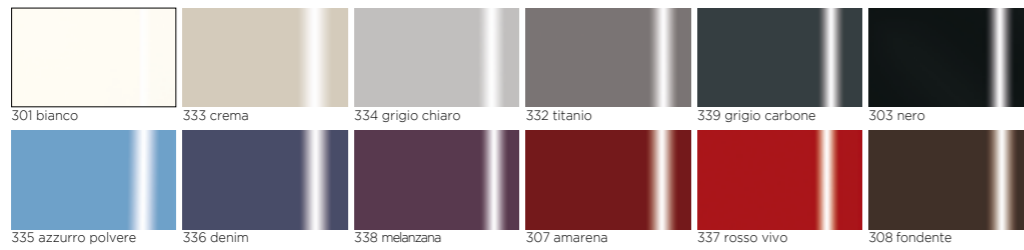

LACQUERED GLASS & NO PRINT / VETRI LACCATI & NO PRINT / LACK-UND NOPRINTGLAS / VERRE LAQUÉ & NO PRINT

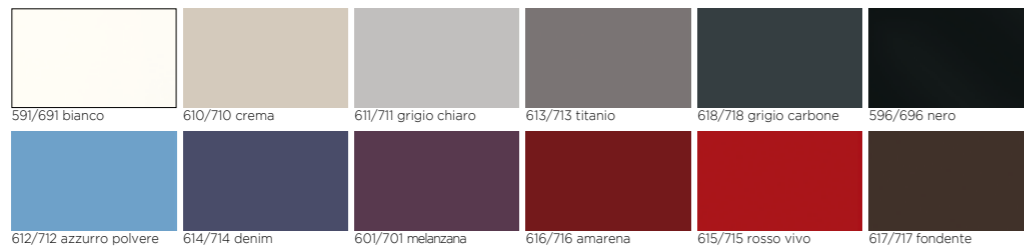

WOOD VENEER / LEGNI / HOLZ / PLACAGE BOIS



MELAMINE / MELAMINICI / MELAMIN / MÉLAMINE



LAMINATE / LAMINATO LAMINAT / STRATIFIÉ



CEMENT / CEMENTO BETON / CIMENT

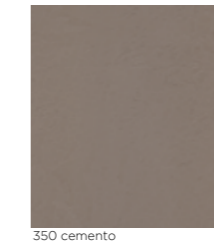

Colours for reference only and may vary from originals / Campioni colore indicativi, possono differire dall'originale.
Die Farbmuster sind rein indikativ. Abweichungen vom Original sind möglich / Echantillons de coloris indicatifs, ils peuvent différer de l'original

FABRICS & LEATHER _ TESSUTI & PELLI STOFFE & LEDER _ TISSUS & CUIR

CAT.A - STRETCHY 3D / STRETCHY 3D / STRETCHY 3D / STRETCHY 3D



CAT.B - FAUX-LEATHER 3D / ECOPELLE 3D / ÖKO-LEDER 3D / SIMILCUIR 3D

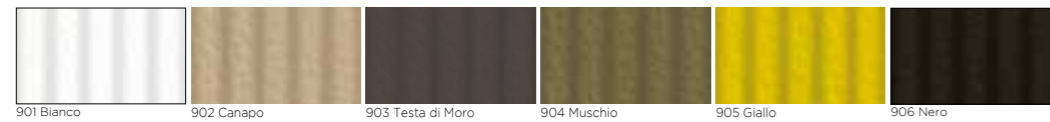

CAT.C - NATIVA / NATIVA / NATIVA / NATIVA

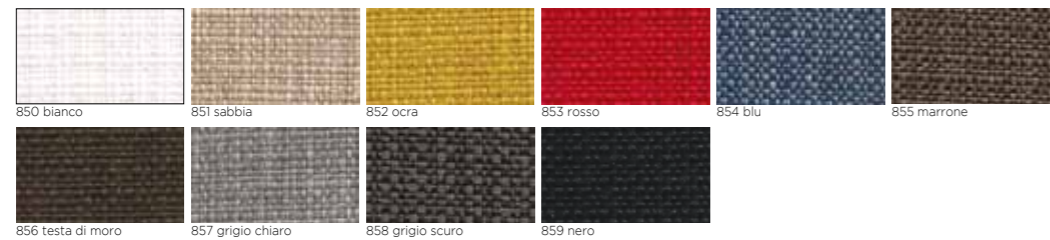

CAT.D - STOPFIRE / STOPFIRE / STOPFIRE / STOPFIRE



CAT.E - FAUX-LEATHER / ECOPELLE / ÖKO-LEDER / SIMILCUIR



CAT.F - 100% PURE NEW WOOL / 100% PURA LANA VERGINE / 100% REINE SCHNURWOLLE / 100% PURE LAINE VIERGE



CAT.G - LEATHER / PELLE / LEDER / CUIR



CAT.M - 100% PURE NEW WOOL 3D / 100% PURA LANA VERGINE 3D / 100% REINE SCHNURWOLLE 3D / 100% PURE LAINE VIERGE 3D

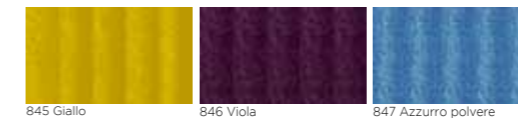

FABRICS AND LEATHERS FROM DIFFERENT LOTS MAY BE SUBJECT TO VARIATIONS AND COLOUR. ANY DIFFERENCES WILL NOT BE RECOGNIZED AS A COMPLAINT.

TESSUTI E PELLI POSSONO ESSERE SOGGETTI A CAMBIAMENTI E A DIFFERENZE DI COLORE TRA LOTTI DIVERSI. EVENTUALI DIFFERENZE NON VERRANNO RICONOSCIUTE COME RECLAMO.

ZWISCHEN UNTERSCHIEDLICHEN PARTIEN VON STOFF UND LEDER KÖNNEN LEICHTE UNTERSCHIEDE IN FARBE ENTSTEHEN. DIESE UNTERSCHIEDE WERDEN NICHT ALS REKLAMATION ANERKANNT.

TISSU ET CUIR DE DIFFÉRENTS LOTS PEUVENT ÊTRE SOUMIS À DES CHANGEMENTS ET À DES DIFFÉRENCES DE COULEUR. LES ÉVENTUELLES DIFFÉRENCES NE SERONT PAS RECONNUS COMME UNE GRIEF.

All rights are reserved. No part of this publication may be reproduced, or transmitted in any form or by any means, electronic, mechanical, photocopying, recording or otherwise, without prior permission of Martex S.p.A. Martex reserves the rights at all time to apply modifications for the functional or qualitative improvement of its products. Texts and drawings present in this brochure have a divulgative purpose: for every technical and dimensional aspect please refer to the company's price lists and their relative updatings. The colour and material samples have an indicative value.

Alle Rechte sind vorbehalten. Kein Teil von diesem Dokument kann reproduziert werden oder mittels jedem elektronischem oder mechanischem Mittel übertragen, copiert, registriert werden, ohne Martex S.p.A. Genehmigung. Martex behaltet sich das Recht vor, in jedem Moment, ohne Ankündigung, Aenderungen vorzunehmen, um die Qualität und die Funktion der Produkte zu verbessern. Texte und Zeichnungen die in diesem Dokument enthalten sind, haben einen reinen wissenschaftlichen Wert. Für jedes technisches oder massliches Detail gelten die Preislisten der Fa.Martex und deren Aktualisierung. Die Farb-und Materialienmuster sind rein indikativ.

Tutti i diritti sono riservati. Nessuna parte di questa pubblicazione può essere riprodotta, o trasmessa in qualsiasi forma o attraverso qualsiasi mezzo elettronico, meccanico, mediante fotocopiatura, registrazione o altro, senza l'autorizzazione di Martex S.p.A. Martex si riserva il diritto di apportare, senza preavviso, ogni modifica mirata al miglioramento funzionale e qualitativo dei propri prodotti. Testi e disegni presenti in questo stampato hanno scopo divulgativo: per ogni aspetto tecnico e dimensionale fare riferimento ai listini aziendali e relativi aggiornamenti. I campioni di colori e materiali hanno valore indicativo.

Tous droits réservés. Aucune partie de la présente publication ne peut être reproduite ou transmise sous quelque forme que ce soit ou par tout moyen électronique, mécanique, ou sous forme de photocopie, sans autorisation écrite préalable du Martex S.p.A. Martex se réserve le droit d'apporter, sans préavis, toute modification utile à améliorer la fonctionnalité et la qualité de ses produits. Les textes et dessins dans ce document sont pour des fins d'information: pour tous les aspects techniques et de dimensions il faut se référer aux tarifs et relatives mises à jour. Les échantillons de couleurs et de matériaux ont une valeur indicative.

CREDITS

Design: Mkt Martex
Photo: Gabriotti Fotografi
Studio Andrea Pitari
Render: Mario Mazzer Architects
Gabriotti Fotografi
Print: www.sincromia.it

Edition: 2016

Martex
via Sagré, 19
Prata di Pordenone (PN) Italy
tel +39 0434 602310
fax +39 0434 602319
info@martex.it
www.martex.it

MARTEX.IT

